



Catalog

2026



TABLE OF CONTENTS

Introduction P02

- P02_** About FEELBAT
- P03_** Advantages of connected sensors
- P04_** Fields of application
- P05_** Current market

Manual Crack Gauge P06

- P08_** DELTA L – Expert pack
- P08_** DELTA L – Essential pack
- P09_** DELTA L - MAX50
- P09_** DELTA L - MAX100
- P10_** Fixing systems
- P10_** Consumables
- P11_** Use case

Connected Crack Gauge P12

- P14_** DELTA L+
- P14_** DELTA L+ - full
- P15_** DELTA L+ - Flat support
- P15_** DELTA L+ - Hollow support
- P16_** Fixing systems
- P18_** Consumables
- P19_** Use case
- P20_** DELTA X-L100
- P21_** Use case
- P22_** DELTA L+ mini - full
- P22_** DELTA L+ mini
- P23_** Fixing systems
- P24_** Consumables
- P25_** Use case
- P26_** DELTA X-L100S
- P27_** Use case

Extensometer P28

- P30_** Pack extenso
- P31_** Fixing systems
- P32_** Consumables
- P33_** Use case

Inclinometer P34

- P36_** DELTA R
- P36_** DELTA R
- P37_** Fixing systems
- P37_** Consumables
- P38_** Use case
- P39_** Inclinometer line
- P42_** Use case

Piezometer P43

- P45_** DELTA X-P
- P46_** Fixing systems
- P47_** Probe lengths
- P48_** Use case
- P49_** DELTA P

Humidity P50

- P52_** DELTA X-Hs
- P53_** Use case
- P54_** DELTA X-Ha
- P55_** Use case
- P56_** DELTA X-Hm
- P57_** Use case

Rain Gauge P58

- P59_** DELTA X-Ra
- P60_** Use case

Logger P61

- P62_** DELTA X
- P63_** Compatible probes

Connectivity P65

Web & Mobile Application P67

- P67_** Mobile application
- P68_** Web application

Feature Pricing P70

Maintenance P71

About

In 2018, in Marseille, a tragic event deeply marked Jean-Christophe HABOT, the founder. Buildings collapsed in his childhood neighborhood, causing several dramatic losses. With his background in building engineering, a question naturally arose: why not develop a way to proactively monitor cracks in order to prevent potential disasters?

This is how FEELBAT was born, driven by the desire to respond to a critical need in building engineering.

The goal?

To make structural monitoring as accessible and efficient as everyday actions facilitated by technology, while contributing to the safety and durability of buildings.

FEELBAT offers innovative connected solutions for the structural monitoring of buildings and infrastructures.

Our sensors provide precise data on cracks, tilting movements, humidity, and much more, enabling remote, real-time monitoring to anticipate potential damage. Quick installation and setup help you save time and stay proactive.

Building experts, surveyors, engineering firms, construction companies, and local authorities — we have the solution to simplify the management of your projects.



Boost your productivity

Monitoring your structures has never been so easy thanks to a real-time application designed by building engineers. Say goodbye to costly surprises and take back control of your buildings' health to ensure the durability of your structures.



Advantages of connected sensors



Early problem detection

Our sensors continuously monitor cracks, tilts, and humidity to respond quickly in case of anomalies.

Decide faster, act earlier.



Process optimization

Data is transmitted automatically, without the need for on-site visits.

Your productivity increases and you react proactively and efficiently.

Gain in responsiveness and performance.



Cost reduction & reliability

Monitor continuously and avoid emergency interventions.

By combining data, diagnostic reliability is strengthened through a global view of the structure's condition.

Enhanced diagnostics, optimized processes.



01

Easily install your sensor



02

Connect it to your phone



03

Monitor your structures in real time



MADE IN FRANCE

Made in France

Most of our suppliers are based in France. Manufacturing and assembly are carried out on French territory.



Tailored and turnkey solutions



Natural risks



Railway



Building / Industry



Civil engineering structures



Geotechnics



Mining

Structural engineering offices

- Correlate data from our sensors and produce effective diagnostics supported by precise curves.

Geotechnical engineering offices

- Automatically monitor groundwater levels and soil moisture to quickly detect soil-structure interactions.

Building & Public Works companies

- Monitor surrounding constructions to measure the impact of your work and react immediately.

Asset managers / Owners

- Secure users thanks to our system that alerts you of any suspicious structural movement.

Experts

- Link the evolution of cracks, soil moisture, and inclination to analyze the impact of clay shrink-swell.

Property managers (Syndics)

- Gain in proactivity as soon as a disorder occurs, ensuring satisfied co-owners.

Surveyors (Geometers)

- Thanks to connected inclinometers, carry out continuous monitoring without heavy investment or site visits.

Architects, Project Managers

- Your construction sites are continuously monitored before, during, and after works, with permanent access to the data.



Structural monitoring

Specific and durable sensors

Innovative technologies for continuous monitoring



Monitoring tool

Mobile and web application

Remote monitoring via Sigfox, 4G and Bluetooth (and soon LoRaWAN)



Dedicated support

Field experts

Personalized solutions, design assistance, and structural expertise



Anticipate to repair

Continuous monitoring

Optimized maintenance costs and predictive planning

Building health, a fundamental necessity

Over the past five years, many civil engineering structures and buildings, particularly in major metropolitan areas such as Bordeaux, Lille, Marseille, and Lyon, have suffered collapses, leading to dramatic consequences.

The aging of our structures requires careful monitoring in order to intervene quickly and apply corrective measures.

Nearly **10.4 million** detached houses are built on clay soils, and currently more than 4,900 structures show a deteriorated state of health. **The shrink-swell phenomenon is spreading exponentially due to climate change.**

Drought now affects new areas, which are facing unprecedented climatic consequences.

In 2022, 370 municipalities were recognized as being in a state of natural disaster, a 44% increase compared to the previous record in 2003 (4,437 municipalities recognized).

Moreover, stability defects **increased by 11% over the same period**, highlighting significant and costly problems, often linked to poorly identified land, especially on former industrial sites.

Not to mention **maintenance defects: for example, 1,500 municipal decrees have been issued for dangerous buildings** since the end of 2018 in Marseille alone.

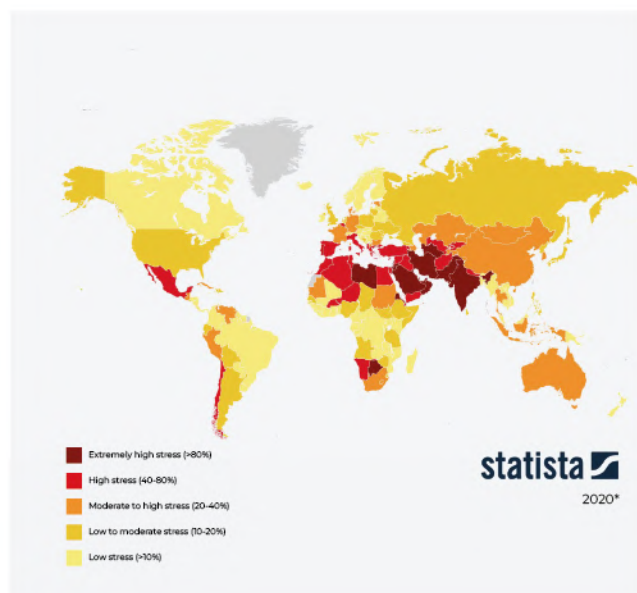

Drought worldwide

Drought now affects more than 1.8 billion people worldwide. In a report published at COP28, the United Nations Convention to Combat Desertification recalled that water scarcity has multiple repercussions.



A hand is shown holding a manual crack gauge against a concrete surface. The gauge is a black, handheld device with a digital display and several buttons. It is being used to measure the width of a crack in the concrete. The crack is a jagged, irregular line. The background is a plain, light-colored concrete wall. The hand is positioned on the left side of the frame, with the thumb and index finger gripping the gauge. The gauge is held against the crack, and the digital display is visible. The overall scene is a close-up shot of the measurement process.

MANUAL CRACK GAUGES

Manual crack gauges

JC1 and JC2 for your cracks

Easy to install, this precise instrument allows users to manually record data related to cracks.

This information can then be easily integrated into the FEELBAT application, providing a simple and organized way to monitor the evolution of deformations.

This combination of manual sensors and digital interface ensures reliable monitoring and optimal crack management, helping to proactively preserve the integrity of structures.



Compact & Resistant



Precise
1/100 mm



Plug & Play
Easy to use and install



Digital
Easy reading for
greater accuracy



4 measurement types
Opening, shear,
misalignment, angular

Features

Battery LR44 - 1,5 V	Weight 0,85kg	Dimensions 22 x 4,5 x 7 cm
Accuracy 0.01 mm	Electronics - Digital reading	Maximum range 14 cm
2 installation modes (glue, hammer-driven anchor)	4 Measurement types	Mounting All types of materials

Available measurements



Opening

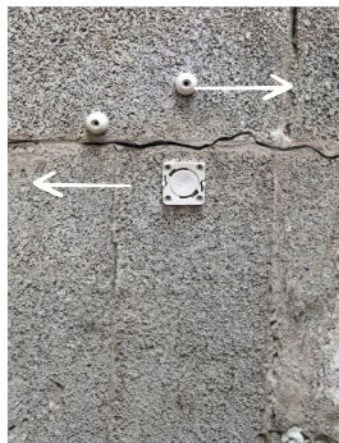

Shear



Angular measurement

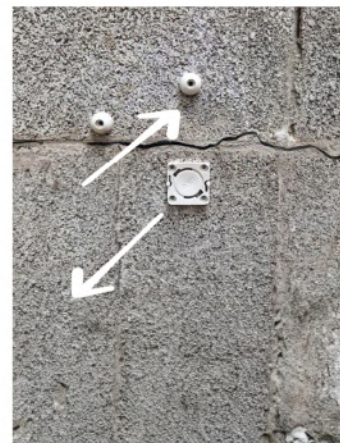

Misalignment

Pack – DELTA L Expert

The DELTA L Expert is a complete **crack gauge that allows you to monitor your cracks on all 3 axes** with high precision.

Simply take your measurements and record them in the application for regular monitoring.

REF : EXDL

199 € excl. VAT

The Expert pack, the most complete in the range, is ideal for **precise monitoring of cracks on the three axes: opening, shear and misalignment**.

Included in the pack

- 1 DELTA L1 electronic measuring ruler
- 10 JC1 polycarbonate gauges for monitoring 5 cracks
- 1 DELTA L2 measuring tool
- 1 DELTA L0 calibration block
- 3 JC2 gauges for monitoring 3 cracks in shear and misalignment
- 25 hammer-in anchors for fixing (drilling \varnothing 5 mm)

Gauges can be fixed using hammer-in anchors or two-component adhesive *(sold separately)*.



Pack – DELTA L Essential

The DELTA L Essential is a crack gauge that allows you **to monitor crack opening** with high precision.

Simply take your measurements and record them in the application for regular monitoring.

REF : ESDL

149 € excl. VAT

The Essential pack is ideal for monitoring crack opening.
This pack allows you to monitor 5 cracks.

Included in the pack

- 1 DELTA L1 electronic measuring ruler
- 1 DELTA L0 calibration block
- 10 JC1 polycarbonate gauges for monitoring 5 cracks
- 10 hammer-in anchors for fixing (drilling \varnothing 5 mm)

Gauges can be fixed using hammer-in anchors or two-component adhesive *(sold separately)*.





DELTA L MAX50

The DELTA L MAX50 pack allows you **to monitor cracks or fractures** with several centimeters of displacement on both axes — opening and shear — thanks to a measuring ruler with a travel of approximately 50 cm.

REF : DLMAX50

899 € excl. VAT

The system is used in the same way as the DELTA L monitoring tool, with JCI gauges and the same features available in the FEELBAT application.

Included in the pack

- 1 DELTA L MAX50 electronic measuring ruler
- 1 storage case
- 1 set of 5 pairs of JCI stainless steel gauges
- 1 DELTA L0 MAX calibration block

For calibration, you can use the DELTA L0 MAX device *(included)*



DELTA L MAX100

The DELTA L MAX100 pack allows you **to monitor cracks or fractures** with several centimeters of displacement on both axes — opening and shear — thanks to a measuring ruler with a travel of approximately 100 cm.

REF : DLMAX100

999 € excl. VAT

The system is used in the same way as the DELTA L monitoring tool, with JCI gauges and the same features available in the FEELBAT application.

Included in the pack

- 1 règle de mesure électronique DELTA L MAX100
- 1 boîte de rangement
- 1 lot de 5 paires de jauges JCI Inox
- 1 étalon DELTA L0 MAX

For calibration, you can use the DELTA L0 MAX device *(included)*





DELTA L Expert Fixings



M5 x 25 Hammer Anchors

Pack of 25 hammer anchors for hollow or solid supports (wood, brick, concrete, stone).

The anchors are galvanized, premium quality, 5 × 37 mm length (may vary from 5 to 7 mm depending on stock).

Sold in the Essential and Expert packs and individually in bags.

REF : SCHFR

10 € excl. VAT



Two-Component Adhesive 10 g

High strength and ultra-fast setting on all supports (concrete, wood, metal, stone, plaster).

Economical 10 g format for extended use.

Durable bonding in 3 to 4 minutes, with initial grip in 1 minute.

REF : KIT7

12 € excl. VAT



Consumables / Accessories



JC1 Light Grey
Polycarbonate measuring
marker for 5 cracks

10 units - 5 pairs
REF : PACJC1G

38 € excl. VAT



**JC1 Stainless Steel
Grey**

Stainless steel measuring
marker for 5 cracks
10 units - 5 pairs

REF : PACJC1I

120 € excl. VAT



JC1 Light Grey
Polycarbonate measuring
marker for 50 cracks

100 units - 50 pairs
REF : 10XPACJC1G

350 € excl. VAT



JC1 Stainless Steel
Stainless steel measuring
marker for 50 cracks

100 units - 50 pairs
REF : 10XPACJC1I

999 € excl. VAT



JC2
Shear and differential
movement measuring plate

X3
REF : PACJC2G

49 € excl. VAT



DELTA L0
Calibration device

REF : DL0

60 € excl. VAT



DELTA L2
Measuring tool

Shear and differential
movement
REF : DL2

60 € excl. VAT



2 Button Batteries
LR44 / A 76 - 1,5 V

For DELTA L1
REF : PIL1x2

4 € excl. VAT



Use case

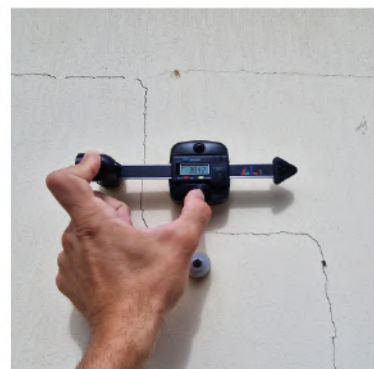
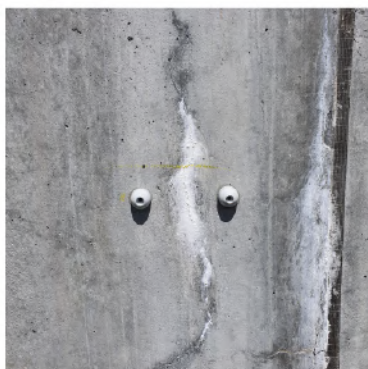
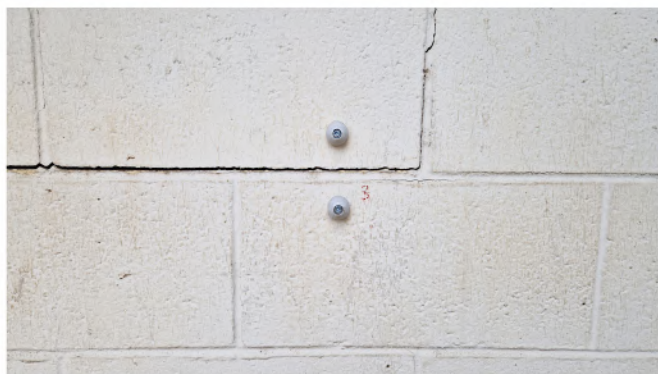
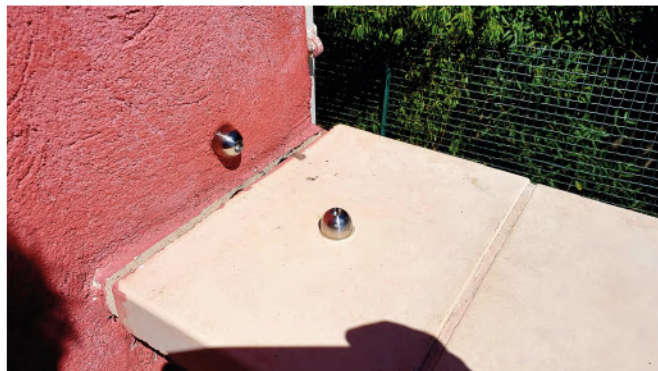



**CONNECTED
CRACK SENSORS**

Cracks

DELTA L+, DELTA XL100, DELTA L+ Mini & DELTA X-L100S

FEELBAT connected crack sensors are designed to ensure accurate and continuous monitoring of structural crack openings. Thanks to their Plug & Play technology, they are easy to install without heavy civil works and transmit data in real time.

Measurements can be viewed on an intuitive web platform or via the FEELBAT mobile application, offering a clear visualization of trend curves and customizable alert configuration.



Compact & Résistant



Precise



Plug & Play



Autonomous



Connected

Adaptable to all types of materials



Hollow support

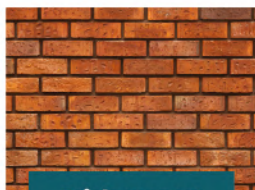

Brick support



Metal support



Wooden support

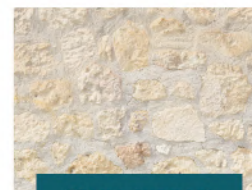

Stone support

Our range of connected crack sensors



DELTA L+

Crack monitoring



DELTA X-L100

Large-amplitude crack monitoring



DELTA L+ mini

The smallest connected crack sensor in the world



DELTA X-L100S

Submersible crack sensor



DELTA L+

The DELTA L+ is a connected sensor designed **to monitor cracks** with precision and full autonomy. It measures crack movements on site or remotely and records the external temperature, all accessible directly from a smartphone.

REF : DLL+

319 € excl. VAT

Features

Battery 3,6 V - 2,6 Ah - Battery life 1 to 4 years*	Weight 250 g	Dimensions 13 cm x 5,5 cm
Resolution 0.01 mm - 1 °C	Connection Bluetooth & LPWAN Radio	Protection IP66
Accuracy 5 µm - 0,5 C (+/-)	Measurement interval from 10 min to 24 h	2 mounting modes
Internal memory 250 000 measurements	Operating temperature -25 °C to +70 °C	Measurement range 0 to 25 mm (+/- 1 mm)

*Depending on measurement frequency, sensor exposure and data transmission mode (Bluetooth, LPWAN...).

Included in the pack

- 1 DELTA L+ crack sensor
- 1 3.6 V battery
- 2 connection caps with plastic ball joint
- 1 hex head screw M6 × 20, stainless steel A4
- 2 M6 nuts, stainless steel A4
- 8 screws for thermoplastic, Z1 stainless steel A2

Mounting advice

- Solid support (PF1)
- Hollow support (PF12)
- Magnetic support (PF8)
- Tri-axis support (TRIAXE)



DELTA L+ – Complete

This mounting pack is designed for installing the DELTA L+ crack sensor **on hollow or solid supports**. The DELTA L+ can be mounted on a flat surface or at an angle. **DELTA L+, mountings and connection token included.**

REF : DLL+FULL

399 € excl. VAT

LinkFeel token included
Remote connection for 1 year

Included in the pack

- 1 DELTA L+ pack
- PF11 pack – solid support **OR** PF12 pack – hollow support
- 1 LinkFeel token (1 year of connection)

Mounting advice

- Refer to the installation manual depending on the type of support.



DELTA L+ – Solid surface

This mounting pack is designed for the installation of the DELTA L+ crack gauge **on solid surfaces** (concrete, solid brick, stone, etc.).

The DELTA L+ can be mounted on a flat surface or at an angle.
DELTA L+ included.

REF : DLL+PF11

348 € excl. VAT



solid surfaces

Included in the pack

- 1 DELTA L+ pack
- PF11 pack – solid surface mounting

Mounting advice

- Air blower
- 10 mm open-end or socket wrench for screws and nuts
- 13 mm open-end (or socket) wrench for concrete anchors
- Hammer (for angled ball joint mounting)
- PH1 Phillips screwdriver
- Drill bit suitable for the surface – Ø 6 mm



DELTA L+ - Hollow surface

This mounting pack is designed for the installation of the DELTA L+ crack gauge **on hollow surfaces** (hollow brick, concrete blocks, drywall, etc.).

The DELTA L+ can be mounted on a flat surface or at an angle.
DELTA L+ included.

REF : DLL+PF12

348 € excl. VAT



on hollow surfaces

Included in the pack

- 1 pack DELTA L+
- + pack PF12 - support creux

Mounting advice

- Air blower
- 10 mm open-end or socket wrench for screws and nuts
- 13 mm open-end (or socket) wrench for concrete anchors
- Hammer (for angled ball joint mounting and anchors)
- PH1 Phillips screwdriver
- Drill bit suitable for the surface – Ø 5 mm



DELTA L+ Mounting Kits



SOLID SURFACE MOUNTING KIT

DELTA L+ mounting kit for **solid surfaces, flat or angled surfaces**, with galvanized concrete anchors.

This pack does NOT include the DELTA L+ crack sensor.

REF : PF11

29 € excl. VAT

Included in the pack

- 2 concrete anchors with female sleeve M6 x 35
- 4 nuts M6, INOX A4
- 2 hex head bolts M6 x 60, INOX A4
- 1 right Igus ball joint for angled mounting
- 1 flat washer M6, INOX A2

Mounting advice

- Drill bit suitable for the surface Ø 6 mm
- Air blower
- 2 open-end (or socket) wrenches of 10 mm for bolts and nuts
- Open-end (or socket) wrench of 13 mm for concrete anchors
- Hammer (for installing the ball joint)



HOLLOW SURFACE MOUNTING KIT

DELTA L+ mounting kit for hollow surfaces, flat or angled surfaces, with galvanized concrete anchors.

This pack does NOT include the DELTA L+ crack sensor.

REF : PF12

29 € excl. VAT

Included in the pack

- 6 nuts M6, INOX A4
- 2 hex head bolts M6 x 60, INOX A4
- 8 hammer-in anchors PZ M5, zinc-plated steel
- 2 polycarbonate brackets, DELTA FIX
- 1 right Igus ball joint for angled mounting
- 1 flat washer M6, INOX A2

Mounting advice

- Drill bit suitable for the surface Ø 5 mm (for anchors)
- Air blower
- 2 open-end or socket wrenches of 10 mm for bolts and nuts
- Phillips screwdriver PH2
- Hammer



DELTA L+ Mounting Systems



MAGNETIC MOUNTING KIT

Drill-free mounting **using magnets for DELTA L+ and DELTA R**, allowing crack or angle measurements without weakening the structure.

This pack does NOT include the DELTA L+ crack sensor.

REF : PF08

35 € excl. VAT

Included in the pack

- 2 pot magnets, ferrite, Ø 32 mm, M6 thread
- 1 Igus ball joint for angle measurements
- 1 flat washer M6, INOX A2
- 2 spacers M6
- 4 nuts M6, INOX A4
- 2 hex head bolts M6 × 60, INOX A4

Lightbulb Mounting advice

- 10 mm open-end or socket wrench
- Phillips screwdriver PH1
- Hammer



TRI-AXIS MOUNTING KIT

The tri-axis bracket is designed to **measure crack movements along three axes: opening, shear, and displacement**, providing a complete and precise analysis of structural evolution.

This pack does NOT include the DELTA L+ crack sensor nor the fixings..

REF : TRIAXE

98 € excl. VAT

Included in the pack

- 1 TRI-AXIS INOX assembly
- 10 Torx countersunk screws M6 × 16, INOX A2
- 13 flanged Nylstop nuts M6, INOX A2
- 4 universal nylon anchors, 10 × 60 (10 mm drilling, M6 screw)
- 4 Torx wood screws, rounded head 6 × 70, INOX A2
- 4 flat washers M6, INOX A2
- 2 nuts M6, INOX A4
- 1 hex head bolt M6 × 60, INOX A4

Lightbulb Mounting advice

- Air blower
- Torx screwdriver T25
- Torx screwdriver T30
- 10 mm open-end wrench
- Drill bit suitable for the surface Ø 10 mm
- Hammer (for inserting nylon anchors)

Installation example





Consumables / Accessories



AA Battery
LS14500

REF : PIL2

18 € excl. VAT



Pack of 5 AA Batteries
LS14500

REF : PILE3

75 € excl. VAT



Threadlocker 271
5ml

REF : COL3

10 € excl. VAT



x2 Ball joint connections
plastiques N°2

REF : ROT2X2

15 € excl. VAT



x2 Ball joint connections
inox N°1

REF : ROT4X2

59 € excl. VAT



x2 ball joint connections
Straight N°3

REF : ROT3X2

20 € excl. VAT



x6 Zinc-plated anchor bolts
M6 x 85 mm

REF : GO75

15 € excl. VAT



x6 Zinc-plated anchor bolts
M6 x 55 mm

REF : GO45

12 € excl. VAT



x4 Concrete anchors
female sleeve - M6 6 x 35

REF : CHB01

10 € excl. VAT



x25 Hammer-in wall plugs
M5 - 47mm

REF : SCHFR

10 € excl. VAT



Zinc-plated drive rod
for sleeve - M6 + 10 sleeve

REF : TIG01

30 € excl. VAT



x10 Drive-in sleeves
zinc-plated steel with collar
M6 x25 mm

REF : DOU01

8 € excl. VAT



Additional DELTA L+ connection

REF : CODL

23 € excl. VAT



Protective enclosure
300 x 200 x 130

REF : BOIT302013

68 € excl. VAT



Use case

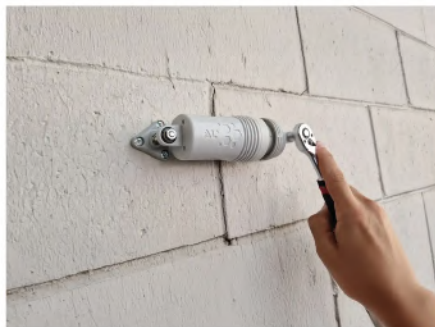



DELTA X-L100

The DELTA X-L100 is a connected electronic potentiometric sensor specifically designed **to monitor large-amplitude crack movements**.

It offers a **displacement range from 0 to 100 mm**. Equipped with a displacement sensor, it features dedicated ball joints for easy fixing at both ends.

REF : DELXL100

739 € excl. VAT

Features

Battery 3,6 V - 17 Ah - Battery life 1 to 7 years*	Probe Protection IP65	Number of movements 100 million
Resolution 0.01 mm - 1 °C	Bluetooth & LPWAN radio connection	Crack gauge length 175 mm
Accuracy 5 µm - 0,5 °C (+/-)	Cable length 2 m	Fixing point Ball joint on both sides
Internal memory 250 000 measurements	Operating temperature - 25° to + 70°	Measurement range 0 to 100 mm

* depending on measurement frequency, sensor exposure and data transmission mode (Bluetooth, LPWAN, etc.).

Included in the pack

- 1 DELTA X sensor
- D batteries 3.6 V
- U bracket inox
- 4 M6 × 8 screws, inox A2
- 2 universal wall plugs 10 × 60, nylon
- 2 wood screws round head 6 × 70, inox A2
- 2 flat washers M6, inox A2
- 1 potentiometric probe
- 2 hex socket head screws with flange, M5 × 35, inox A2
- 2 spacers M5, inox A2
- 2 Nylock nuts M5, inox A2
- 2 DELTA FIX
- 8 hammer-in wall plugs PZ head M5, zinc-plated steel

Mounting advice

WARNING - Fixings are Ø5 mm at the ball joints

- T20 screwdriver
- T30 screwdriver for locking screw
- TORX 25 screwdriver
- Ø10 mm drilling for nylon wall plug
- PH3 Phillips screwdriver
- 8 mm open-end wrench
- 3 mm Allen key

DELTA X-L100

sold separately



Logger X

REF : DLLX

449 € excl. VAT



Potentiometric probe
X-L100

REF : SXL100

325 € excl. VAT



Use case

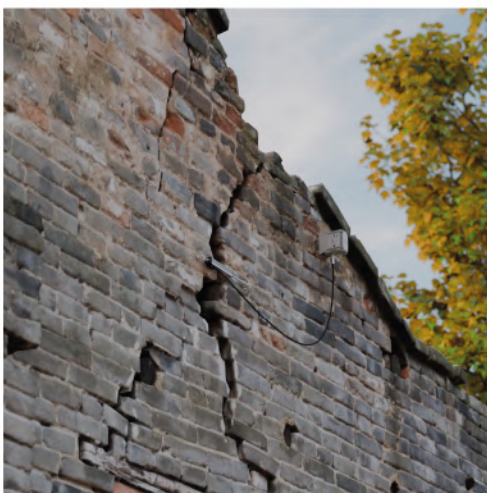
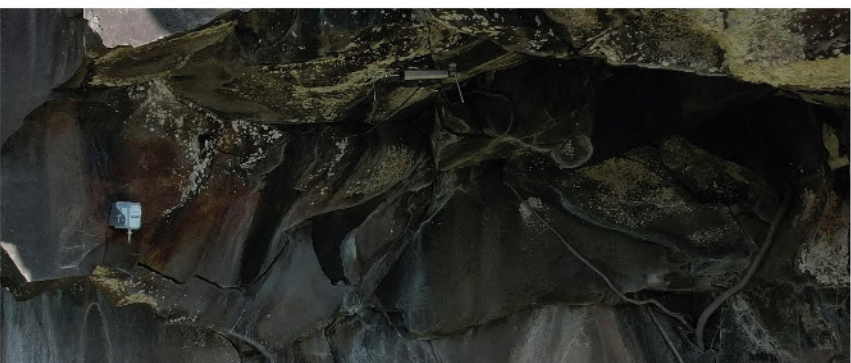



Jeton Linkfeel included
Remote connection – 1 year

DELTA L+ mini

The DELTA L+ mini provides **accurate and autonomous crack monitoring**, as well as monitoring of the impact related to sun exposure on façades.

It can be fixed by bonding using our patented device or mechanically fixed.

Linkfeel connection token and fixings included in the pack!

REF : DLL+miniJET

399 € excl. VAT

Features

Battery 3,6 V - 3,6 Ah - Battery life 1 to 5 years*	Weight 150 g	Dimensions 14,5 cm x 4,7 cm x 3,5 cm
Resolution 0.01 mm - 1 C°	Bluetooth & LPWAN radio connection	Protection IP66
Accuracy 5 µm - 0,5 C° (+/-) - 0,085 mm/m	Measurement interval from 10 min tp 24 h	2 mounting modes
Internal memory 250 000 measurements	Operating temperature -25 °C to +70 °C	Measurement range from 0 to 20 mm (+/-1 mm)

* depending on measurement frequency, sensor exposure and data transmission mode (Bluetooth, LPWAN, etc.).

Included in the pack

- 1 DELTA L+ Mini sensor and its mounting pack
- As a gift: 2 JCI crack gauges
- 1 one-year connection token

Lightbulb Mounting advice

- Screwdriver with T15 bit
- Screwdriver with T20 bit
- 10 mm open-end or socket wrench (for M6 nuts)
- Hammer (to drive in wall plugs)
- Ø5 mm drilling for hammer-in wall plug
- Ø10 mm drilling for nylon wall plug
- PH3 Phillips screwdriver



DELTA L+ mini

The DELTA L+ mini provides **accurate and autonomous crack monitoring**, as well as monitoring of the impact related to sun exposure on façades.

It can be fixed by bonding using our patented device or mechanically fixed.

Fixings included in the pack!

REF : DLL+mini

350 € excl. VAT

Included in the pack

- Kit "7" two-component adhesive 10G
- Square for angled installation
- 1 Torx round head screw, M6 × 15, inox A2
- 1 low nut M6, inox A2
- 2 flat washers M6, inox A2
- 2 universal wall plugs 10 × 60, nylon
- 2 Torx wood screws, round head 6 × 70, inox A2
- 2 hammer-in wall plugs PZ M5, zinc-plated steel
- As a gift: 2 JCI crack gauges

Lightbulb Mounting advice

- Screwdriver with T15 bit
- Screwdriver with T20 bit
- 10 mm open-end or socket wrench (for M6 nuts)
- Hammer (to drive in wall plugs)
- Ø5 mm drilling for hammer-in wall plug
- Ø10 mm drilling for nylon wall plug
- PH3 Phillips screwdriver



DELTA L+ mini Mounting Kits



BI-COMPONENT ADHESIVE MOUNTING KIT

The pods are fixed directly onto the surface, previously prepared using the supplied adhesive. The mixer ensures a uniform application of the product. The pusher is used to facilitate sensor positioning during installation.

REF : PFMIN01

35 € excl. VAT

Included in the pack

- 1 pusher
- 2 isopropyl alcohol wipes 70%
- 4 pods
- 1 bi-component adhesive 10 g
- 3 mixers
- 4 plastic screws Ø 3.5, INOX A4

Lightbulb Mounting advice

- Quick adhesive fixing (sets in 3 seconds)

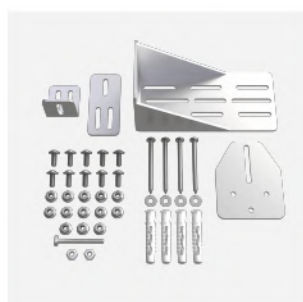

Tri-axis Mounting Kit

The tri-axis bracket is designed to **measure crack movements along three axes: opening, shear, and offset**, providing a complete and precise analysis of structural evolution.

This pack does not include the DELTA L+ mini crack sensor.

REF : TRIAXE

98 € excl. VAT

Included in the pack

- 1 tri-axis INOX assembly
- 10 Torx countersunk screws, M6 × 16, INOX A2
- 13 Nylstop countersunk nuts, M6, INOX A2
- 4 universal wall plugs 10 × 60, Nylon (drilling Ø10, M6 screw)
- 4 Torx wood screws, round head 6 × 70, INOX A2
- 4 flat washers M6, INOX A2
- 2 nuts M6, INOX A4
- 1 hex head screw M6 × 60, INOX A4

Lightbulb Mounting advice

- T25 screwdriver
- T30 screwdriver
- 10 mm open-end wrench
- 13 mm open-end wrench
- Drill bit Ø10 mm adapted to the surface
- Hammer (to insert Nylon wall plugs)

Installation example

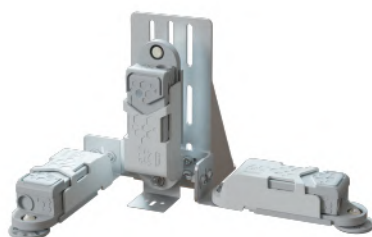



Consumables / Accessories



Threadlocker 271 5 ml

REF : COL3

10€ excl. VAT



6 x Galvanized anchor bolts M6 x 85 mm

REF : GO75

15 € excl. VAT



6 x Galvanized anchor bolts M6 x 55 mm

REF : GO45

12 € excl. VAT



25 x Hammer-in wall plugs M5 - 47 mm

REF : SCHFR

10 € excl. VAT



Bi-component adhesive 10 g

REF : KIT4

12 € excl. VAT



Protective enclosure 300 x 200 x 130

REF : BOIT302013

68 € excl. VAT



DELTA L+ mini battery Battery 17500

REF :PIL6

14 € excl. VAT



5 x DELTA L+ mini batteries Battery 17500

REF :PILE6

60 € excl. VAT



Use case

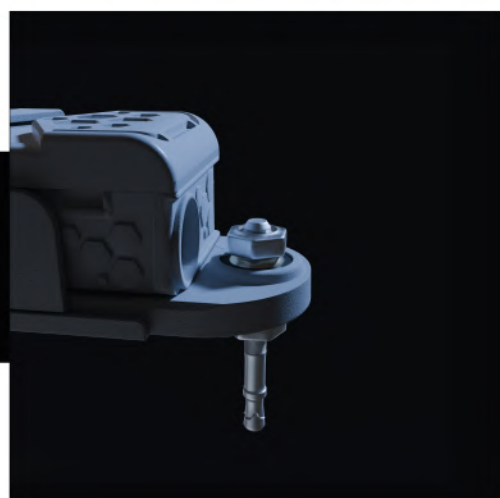
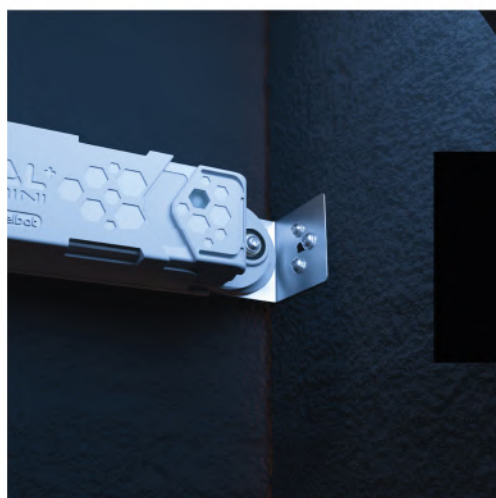
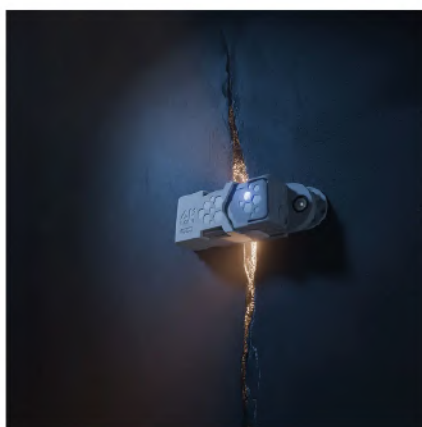



DELTA X-L100S

The DELTA X-L100S is a submersible crack-monitoring sensor offering a 100 mm stroke, designed for the most demanding environments.

Combined with the DELTA X logger, it measures temperature and automatically records and transmits data for precise and continuous monitoring. **Only the sensor is submersible.**

REF : DXS100

1 484 € excl. VAT

Features

Battery 3,6 V - 17 Ah - Battery life 1 to 7 years*	Probe protection IP68	Cable length 10 m
Resolution 0.01 mm - 1 °C	Bluetooth & LPWAN radio connection	Max force 120 N
Accuracy 0.5 % PE - 0.5 °C	Metal connector, waterproof and rugged	Environmental variation compensation
Internal memory of 250,000 measurements	Operating temperature -40 °C à +85 °C	Measuring range 100 or 250 mm

*depending on frequency, sensor exposure and data transmission mode (Bluetooth, LPWAN, etc.).

Included in the pack

- 1 DELTA X sensor
- 1 D battery 3.6 V
- 1 U bracket – inox
- 4 M6 × 8 screws – inox A2
- 4 universal nylon wall plugs 10 × 60
- 4 Torx wood screws, round head 6 × 70 – inox A2
- 4 flat washers M6 – inox A2
- 1 submersible probe – 100 mm stroke

Mounting advice

WARNING - Fixings use Ø5 mm at the ball-joint level

- T20 screwdriver
- Ø10 mm drilling for nylon wall plugs
- T30 screwdriver for locking screw
- T25 screwdriver

DELTA X-L100S

sold separately

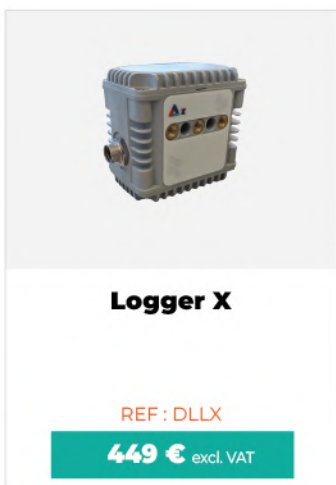

Logger X

REF : DLLX

449 € excl. VAT



Use case



Convergence

DELTA L+ Extenso Pack

With the DELTA L+ Extenso Pack, you transform your sensor into a convergence meter.

The DELTA L+ Extenso Pack enables accurate displacement measurements over long distances. Thanks to its plug & play technology, it is easy to install without heavy works and transmits data in real time.

Measurements can be viewed via an intuitive web platform or via the FEELBAT mobile application, offering clear visualization of trend curves and customizable alerts.



Compact & Resistant



Precise



Plug & Play



Autonomous



Connected

Adaptable to all types of materials



Solid surface

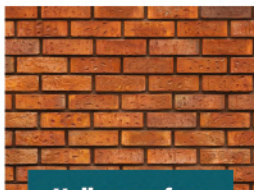

Hollow surface

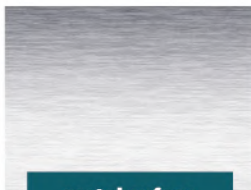

metal surface



wooden surface

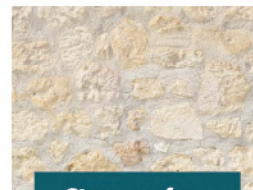

Stone surface

When should convergence measurement be used?

Different use cases

Convergence measurement is used in many contexts, such as:

- Monitoring the evolution of an arch
- Measuring the behavior of vertical walls
- Monitoring the deflection of a floor
- Tracking cracking or movement between two tunnel walls
- Monitoring a structure or building during construction works
- Preventive actions for short-, medium-, or long-term maintenance
- During demolition works

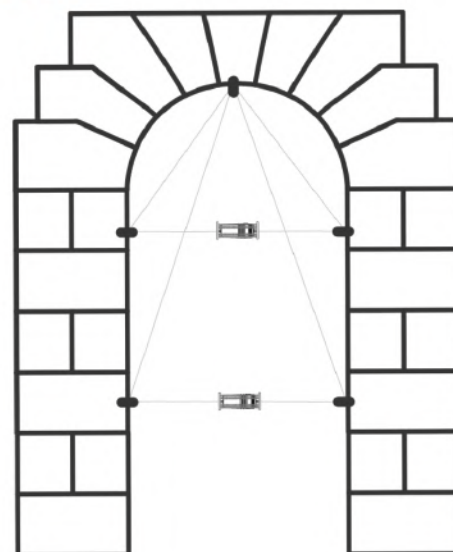

10 ML

Extenso Pack – DELTA L+

The Extenso Pack includes **all the components required for installing the extensometer.**

It allows the stability or structural integrity to be assessed by detecting convergence variations.

A DELTA L+ sensor is required (sold separately).

REF : PEX10

349 € excl. VAT

Features

Battery 3,6 V - 2,6 Ah - Battery life 1 to 4 years*	Weight 450 g	Dimensions 20 cm x 85 cm
Resolution 0.01 mm - 1 °C	Connection: Bluetooth & Radio LPWAN	Protection IP66
Accuracy 5 µm - 0,5 °C (+ or -)	Measurement interval from 10 min to 24 h	INVAR wire of various lengths
Internal memory 250 000 measurements	Operating temperature -25 °C to +70 °C	Measurement rang 0 to 25 mm (+ or -)

*depending on the sampling frequency, sensor exposure and data transmission mode (Bluetooth, LPWAN, etc.)

Included in the Pack

- 1 extenso assembly
- 3 return springs
- 2 low-profile M6 nuts, INOX A2
- 1 turnbuckle 6 × 110, galvanized steel
- 2 M6 eye nuts, INOX A4
- 2 eye anchors
- 1 cover with hexagonal screw M6 × 20, INOX A4
- 2 M6 nuts, INOX A4
- 10 m INVAR extenso wire

Mounting advice

- Drill with bit adapted to the surface (Ø14 mm for eye anchors)
- 10 mm open-ended wrench (M6 nuts and eye nuts)
- 10 mm open-ended wrench (for M6 × 20 screw)
- PH1 Phillips screwdriver (connection cover)
- Hammer
- 2.5 mm Allen key
- Scissors or cutting pliers

20 m

Pack Extenso
20 m INVAR wire

REF : PEX20

469 € excl. VAT



Extenso Pack Mounting Accessories

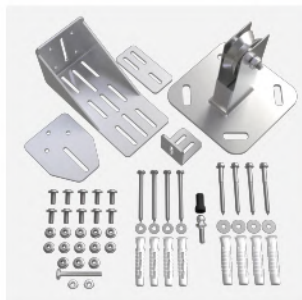

Angle Mounting Pack with Offset Pulley

It allows you to measure the distance between two walls when this distance exceeds 6 to 8 meters. With an angle bracket mounting, the sensor can be offset in an accessible area, making maintenance easier.

Also available with a 45 cm offset pulley.

REF : FPEX15

235 € excl. VAT

Included in the pack

- 1 TRI-AXE mounting pack
- 1 straight Igus joint
- 1 offset pulley 15 cm
- 4 universal anchors, 12×60, NYLON
- 4 wood screws, hex head, 8×70, INOX A2
- 4 flat washers M8, inner Ø 8.4; outer Ø 18, INOX A2

Lightbulb Mounting advice

- Ø10, Ø12, Ø14 mm drill bits adapted to the material (for universal nylon anchors 12×60)
- Open-end wrench or socket wrench 13 mm (for 8×70 hex-head wood screws)
- PH1 Phillips screwdriver (if additional tightening of the cover or accessories is needed)
- Hammer
- Air blower
- T25 screwdriver
- T30 screwdriver
- 10 mm open-end wrench



Consumables / Accessories

10 m



INVAR Wire Spool
10 ML

REF: INV10

129 € excl. VAT

20 m



INVAR Wire Spool
20 ML

REF: INV20

242 € excl. VAT



Use case





**TILT AND
DEFORMATION
SENSORS**

Tilt and deformation

DELTA R and Inclinometric Line

Connected tilt sensors and inclinometric lines from FEELBAT are designed to provide accurate and continuous monitoring of structural movements and deformations. Thanks to their Plug & Play technology, they are easy to install, require no heavy work, and transmit data in real time.

Measurements are accessible through an intuitive web platform or via the FEELBAT mobile app. The interface offers a clear visualization of tilt variations, long-term trend monitoring, and customizable alerts to anticipate any critical structural evolution.



Compact & Resistant



Precise



Plug & Play



Autonomous



Connected

Adaptable to all types of materials



Hollow support

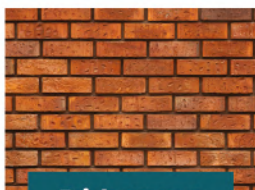

Brick support



Metal support

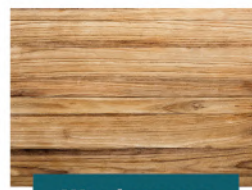

Wood support

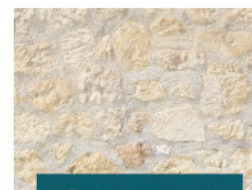

Stone support

Our range of sensors

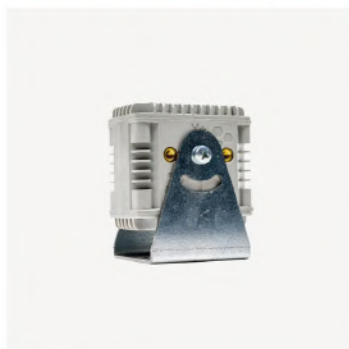

DELTA R

Tilt monitoring



Ligne inclinométrique

Deformation monitoring



DELTA R

The DELTA R is a **bi-axial tilt sensor** designed to accurately monitor the tilt movements of walls or structures. Fully autonomous, it also measures outdoor temperature, which can be viewed directly from a smartphone.

Fixings included

REF : DLLR

425 € excl. VAT

Features

Battery 3,6 V - 17 Ah - Battery life 1 to 7 years*	Weight 350 g	Dimensions 8 x 8 cm / Thickness 5 cm
Resolution 0,01 ° (angles) - 1 ° (T°)	Connection Bluetooth & LPWAN Radio	Protection IP66
Accuracy 0,005 ° (angles) - 0,5 °C	Measurement interval from 10 min to 24 h	2 mounting modes
Internal memory 250,000 measurements	Operating temperature -25 °C to +70 °C	Measurement range 10° degrés (+ / -)

*depending on frequency, sensor exposure, and data transmission mode (Bluetooth, LPWAN, etc.)

Included in the pack

- 1 DELTA R sensor
- 1 D-cell battery 3.6 V
- 1 stainless-steel U-mount
- 4 M5 x 8 screws, INOX A2
- 2 universal anchors 10 x 60, NYLON
- 2 round-head wood screws 6 x 70, INOX A2
- 2 flat washers M6, INOX A2

Lightbulb icon Mounting advice

- T20 screwdriver
- Ø10 mm drilling for nylon anchors
- T30 screwdriver for retaining screw
- T25 screwdriver
- Air blower



DELTA R

The DELTA R is a **bi-axial tilt sensor** designed to accurately monitor the tilt movements of walls or structures. Fully autonomous, it also measures outdoor temperature, which can be viewed directly from a smartphone.

Fixings and 1-year Linkfeel token included

REF : DLLRJET

475 € excl. VAT

Linkfeel token included
1-year remote connection

Included in the pack

- 1 DELTA R pack
- 1 Linkfeel token included

Lightbulb icon Mounting advice

- T20 screwdriver
- Ø10 mm drilling for nylon anchors
- T30 screwdriver for retaining screw
- T25 screwdriver
- Air blower



DELTA R Mounting Accessories



MAGNETIC MOUNTING KIT

Drill-free mounting **using magnets for DELTA L+ and DELTA R**, allowing crack or angle measurements without weakening the structure.

This pack does NOT include the DELTA R crack sensor.

REF : PF08

35 € excl. VAT

Included in the pack

- 2 pot magnets, ferrite, Ø 32 mm, M6 thread
- 1 Iigus ball joint for angle measurements
- 1 flat washer M6, INOX A2
- 2 spacers M6
- 4 nuts M6, INOX A4
- 2 hex head bolts M6 × 60, INOX A4

Mounting advice

- 10 mm open-end or socket wrench
- Phillips screwdriver PH1
- Hammer



Consumables / Accessories



Type D Battery
3,6v DELTA R

REF : PIL4

35 € excl. VAT

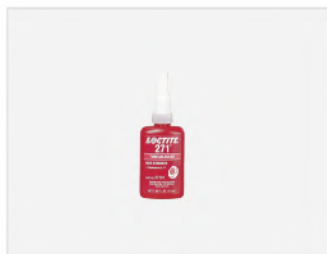

Threadlocker 271
5 ml

REF : COL3

10 € excl. VAT



Protective enclosure
300 x 200 x 130

REF :BOIT302013

68 € excl. VAT



Use case

2 angle measurements
X et Y

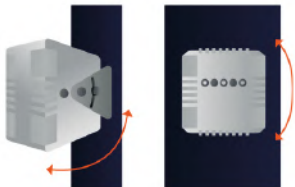



Inclinometric Line

The inclinometric line makes it possible to **monitor global structural deformations and millimetric displacements over long distances.**

Each aluminium segment is mounted on bi-axial articulated brackets, allowing freedom of movement and enabling full tracking of structural variations.

**** Want to know more? Call us! ****

Features

Battery 3,6 V - 17 Ah - Battery life 1 to 7 years*	Anodized aluminium structure	Measurement range $\pm 30^\circ$ (+ / - 10°)
Angular resolution 0,01 °	Bluetooth & LPWAN Radio connection	Protection IP66
Angular precision 0,005 °	Simple wall-mounted or chained installation	Articulated bracket mounting
Internal memory 250,000 measurements	Operating temperature -25 °C to +70 °C	Modular assembly segm. from 0.5 m to 2 m

*depending on frequency, sensor exposure, and data transmission mode (Bluetooth, LPWAN, etc.)

Included in the pack

- See the list of individual elements

Mounting advice

- Drill bit adapted to the surface
- Hammer
- Anchors (4 per inter-segment joint)
- Screwdrivers: T20 – T30
- Wrenches: 10 – 12 – 17





Elements of the Inclinometric Line



ALUMINIUM INCLINOMETRIC SEGMENT – 0.5 M

Each aluminium segment is mounted on bi-axial articulated brackets, providing freedom of movement to track all structural variations.

REF : PI05

188 € excl. VAT



ALUMINIUM INCLINOMETRIC SEGMENT – 1 M

Each aluminium segment is mounted on bi-axial articulated brackets, providing freedom of movement to track all structural variations.

REF : PI1

224 € excl. VAT



ALUMINIUM INCLINOMETRIC SEGMENT - 2 M

Each aluminium segment is mounted on bi-axial articulated brackets, providing freedom of movement to track all structural variations.

REF : PI2

276 € excl. VAT



SEGMENT CONNECTOR

This connector allows free assembly of inclinometric line segments to achieve the desired length.

For example, it enables you to connect a 2 m segment with a 1 m segment to obtain a total length of 3 m.

REF : PICONECT

57 € excl. VAT

Included in the pack

- 4 M10 nuts, INOX A2
- 2 M10 × 60 hex-head screws, INOX A2
- 1 clamp assembly

Mounting advice

- x2 17 mm wrenches



ARTICULATION BRACKET

Inclinometric line segment bracket – lateral mounting.

It must always be used together with the inter-segment articulation.

Important: this bracket is an add-on to the underside mounting support; it is sold separately.

REF : PIEQU

52 € excl. VAT

Included in the pack

- 1 inclinometric segment bracket
- 4 universal anchors, 12 × 60, NYLON
- 4 hex-head wood screws, 8 × 70, INOX A2
- 4 flat washers M8, inner Ø 8.4; outer Ø 18, INOX A2

Mounting advice

- 13 mm wrench



INTER-SEGMENT ARTICULATION

This 2-axis articulation is designed to connect two inclinometric line segments while allowing flexible movement. Ideal for underside mounting.

REF : PISUPP

86 € excl. VAT

Included in the pack

- 1 hex-head screw M10 × 60, INOX A2
- 1 M10 nut, INOX A2
- 2 low-profile M10 nuts, INOX A2
- 1 M8 nut, INOX A2
- 1 Teflon disc D93
- 4 Teflon discs D70
- 1 support assembly
- 4 universal anchors, 12 × 60, NYLON
- 4 hex-head wood screws, 8 × 70, INOX A2
- 4 flat washers M8, inner Ø 8.4; outer Ø 18, INOX A2

Mounting advice

- x2 17 mm wrenches
- One 13 mm wrench



DELTA R MOUNTING BRACKET

This bracket allows you to fasten the DELTA R easily and securely.

The DELTA R is not included.

REF : PIFIX

57 € excl. VAT

Included in the pack

- 8 Torx screws M6 × 8, INOX A2
- 4 Torx countersunk screws M4 × 12, INOX A2
- 2 smooth-base M6 nuts, INOX A2
- 1 DELTA R mounting bracket assembly

Mounting advice

- T30 screwdriver
- T20 screwdriver
- 10 mm wrench



Use case





PIEZOMETRIC SENSORS

Groundwater Level Monitoring

DELTA X-P

The DELTA X-P is a piezometric sensor that continuously measures the groundwater level and its variations, for example after a rainfall event. Easy to install (plug & play) and requiring no heavy works, it transmits data in real time and remotely.

Measurements are accessible through an intuitive web platform or via the FEELBAT mobile app.



Compact & Resistant



Precise



Plug & Play



Autonomous



Connected

Our range of connected piezometers



DELTA X-P

Groundwater monitoring without mounting support



DELTA X-P F1

Groundwater monitoring with external mounting support



DELTA X-P F2

Groundwater monitoring with secured mounting enclosure



DELTA P

Groundwater monitoring for sealed or capped wells

10 m



DELTA X-P - 10 M

The DELTA X-P sensor is supplied with an **immersed piezometric probe designed to monitor groundwater level variations.**

The piezometric probe is equipped with a reinforced cable and a waterproof connector, also integrating an atmospheric pressure compensation system.

REF : DLXP10

799 € excl. VAT

Features

Battery 3,6 V - 17 Ah - Battery life 1 to 7 years*	Enclosure protection IP66	Operating T° -20 °C to +60 °C (liquid phase)
Bluetooth & LPWAN Radio connection	T° measurement module - Accuracy 1 °C	Probe accuracy < +/- 0.3 % FS
Measurement interval from 10 min to 24 h	Probe drift < +/- 0.02 % FS / °C <i>Value given for depths > 4 m, drift (-20 to +60 °C) ±0.03% of FS / °C</i>	316L stainless steel probe, passivated
Internal memory 250 000 measurements	Available cable lengths 10 and 20 m	Probe Ø 21.4 mm +/- 0.1 mm, length 170 mm +/- 0.2 mm

*depending on transmission frequency, sensor exposure, and communication mode (Bluetooth, LPWAN, etc.)

Included in the pack

- 1 DELTA X logger unit
- 1 piezometric probe with 10 m cable

Mounting advice

Important: the mounting kit is not included

- TORX T20 wrench
- Manual piezometric probe

20 m



DELTA X-P

Probe with 20 m cable

REF : DLXP20

899 € excl. VAT

X m



DELTA X-P

Variable cable length available on request

REF : DLXPX

on request



DELTA X-P Mounting Kits



PACK DE FIXATION 1

The X-P mounting kit provides a complete solution to install your DELTA X-P sensor in outdoor environments. This pack includes all the elements required for optimal assembly, ensuring stable and durable installation.

REF : PFXP01

250 € excl. VAT

Included in the pack

- 1 galvanized steel mounting pole
- 6 cable ties
- 6 wood screws
- 1 atmospheric enclosure mount

Lightbulb Mounting advice

The padlock is not included in the pack

Important: the DELTA X-P sensor is not included



PACK DE FIXATION 2 - Enclosure

The X-P enclosure mounting kit provides a complete solution to install and secure your DELTA X-P sensor in outdoor or industrial environments. This pack includes all components needed for optimal installation, ensuring stable mounting and protection against external elements.

REF : PFXP02

149 € excl. VAT

Included in the pack

- 1 ABS enclosure Ø 90 mm pre-drilled, with integrated DELTA X mounting, lockable door
- 1 cable guide 60–75
- 3 nylon cable ties
- 8 smooth-base nuts M6, INOX A2
- 4 hex-head screws M6 × 100

Lightbulb Mounting advice

Important: the DELTA X-P sensor is not included

- 10 mm socket wrench for nuts
- Concrete bag (for pole installation)
- Trowel
- Manual piezometric probe
- T20 screwdriver

DELTA X-P Probe

sold separately



Logger X

REF : DLLX

449 € excl. VAT

10 m



Piezometric probe
10 m

REF : SXP10

449 € excl. VAT

20 m



Piezometric probe
20 m

REF : SXP20

549 € excl. VAT



Use case

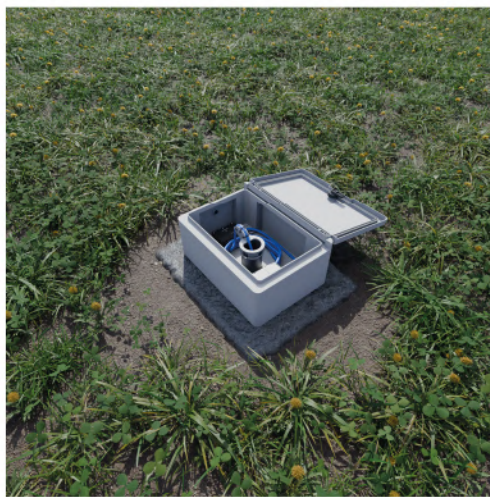
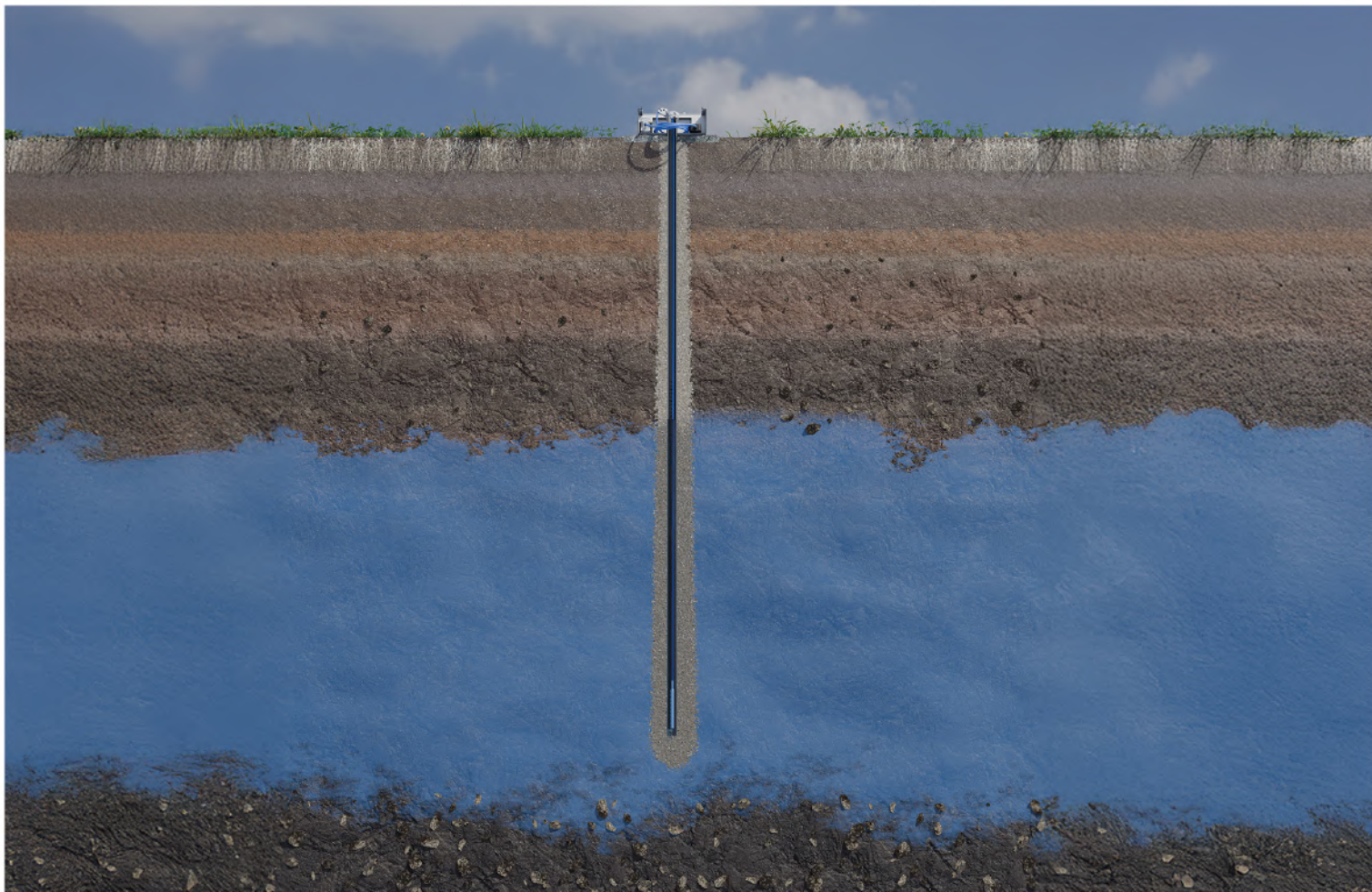



DELTA P

The immersed DELTA P **piezometric probe** allows **discreet monitoring of groundwater level variations**.

Thanks to its compact design and low-visibility installation, it is less exposed to risks of theft or damage.

On request – Custom cable length available

Features

Battery 3,6 V - 17 Ah - Battery life 1 to 7 years*	Enclosure protection IP68	Operating T° -20°C to +60°C (<i>liquid phase</i>)
Bluetooth & LPWAN Radio connection	Temperature module - Accuracy 1 °C	Probe accuracy < 0.3% FS
Measurement interval 10 min to 24 h	Drift in T° (0° à 40°C) < (+/-) 0.02% FS / °C	Passivated stainless steel 316L probe
Internal memory 250,000 measurements	Storage T° 0°C to +80 °C after first use	Probe Ø 21.4 mm +/- 0.1mm, length 170mm +/- 0.2 mm

*suivant l'espacement de mesure choisi, l'exposition du capteur et le mode de transfère des données (bluetooth, LPWAN, ...)

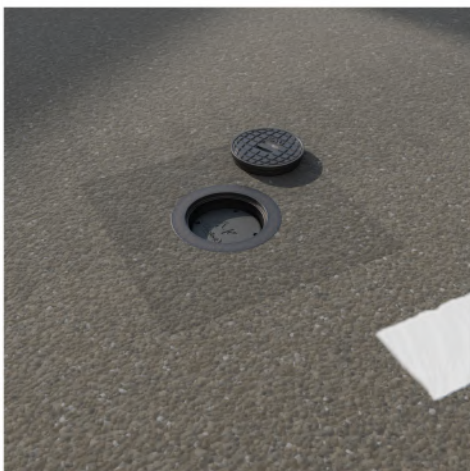

HUMIDITY SENSORS

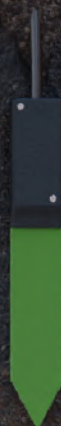

Humidity Measurement Sensors

DELTA X-Hs and DELTA X-Ha

FEELBAT soil and ambient humidity sensors provide high-precision measurement of humidity variations, both indoors and outdoors. Easy to install (plug & play), they transmit data in real time and remotely.

Measurements are accessible through an intuitive web platform or via the FEELBAT mobile application, offering clear visualization of humidity variations, detailed historical tracking, and alert configuration to detect any abnormal evolution.



Compact & Resistant



Precise



Plug & Play



Autonomous



Connected

Our humidity sensor range



DELTA X-Hs

Soil humidity level monitoring



DELTA X-Ha

Ambient humidity monitoring



DELTA X-Hm

Material humidity monitoring



DELTA X-Ra

Rain gauge sensor



DELTA X-Hs

The DELTA X-Hs is a connected sensor equipped with an electronic probe. **This system measures soil humidity with high precision and full autonomy.**

The probe is buried at the foot of the structures and provides relevant data for effective diagnostics, particularly in the context of clay shrink–swell (RGA).

REF : DLXH

699 € excl. VAT

Features

Battery 3,6 V - 17 Ah - Battery life 1 to 7 years*	Enclosure protection IP66	Operating temperature -25 °C to +70 °C
Resolution 1 %	Bluetooth & LPWAN Radio connection	Measurement range 0 to 60% vwc (upper limit depending on soil)
Accuracy 3% up to 50 vwc** **(Volumetric Water Content)	Measurement interval from 10 min to 24 h	External temperature measurement
Internal memory 250 000 measurements	Probe cable length 10 m	Probe 18.2 cm x 3 cm x 1.2 cm

*depending on measurement interval, sensor exposure, and data transfer mode (Bluetooth, LPWAN...)

Included in the pack

- 1 DELTA X sensor
- 1 battery 3.6 V
- 1 stainless-steel U-bracket
- 4 screws M6 × 8, INOX A2
- 2 universal anchors 10 × 60, NYLON
- 2 hex-head wood screws 6 × 70, INOX A2
- 2 flat washers M6, INOX A2
- 1 Hs probe

Mounting advice

- T20 screwdriver
- 10 mm drill bit for nylon anchor
- T30 screwdriver for mounting
- T25 screwdriver

DELTA X-Hs Probe

sold separately



Logger X

REF : DLLX

449 € excl. VAT



Soil humidity probe

REF : SXH

275 € excl. VAT



Use case





DELTA X-Ha

The DELTA X-Ha sensor is equipped with a measurement probe designed **to monitor ambient humidity variations**. Values are expressed as a percentage (0–100%).

REF : DLXHA

699 € excl. VAT

Features

Battery 3,6 V - 17 Ah - Battery life 1 to 7 years*	Weight 350 g + 140g (enclosure)	Dimensions 100 x 122 x 50,5 mm
Metal connector, waterproof and robust	Bluetooth & LPWAN Radio connection	Protection IP65
Accuracy (+/-) 3 % RH	Measurement interval 0 min to 24 h	Wall mounting
Internal memory 250,000 measurements	Operating temperature -40 °C to +60 °C	Measurable humidity 0-100 %

*depending on measurement frequency, sensor exposure, and data transmission mode (Bluetooth, LPWAN, etc.)

Included in the pack

- 1 DELTA X sensor
- 1 battery 3.6 V
- 1 stainless steel U-bracket
- 4 screws M6 × 8, INOX A2
- 2 universal anchors 10 × 60, NYLON
- 2 round-head wood screws 6 × 70, INOX A2
- 2 flat washers M6, INOX A2
- 1 Ha probe
- 2 universal anchors 6 × 45, NYLON
- 2 flat washers M4, INOX A2
- 2 wood screws 4 × 40, INOX A2

Mounting advice

- T20 screwdriver
- T30 screwdriver for mounting screws
- T25 screwdriver

DELTA X-Ha

sold separately



Logger X

REF : DLLX

449 € excl. VAT



Ambient humidity probe

REF : SHA

275 € excl. VAT



Use case



DELTA X-Hm

The DELTA X-Hm sensor is equipped with a measurement probe designed **to monitor the evolution of moisture within materials.**

Values are expressed as a percentage (0–100%).

REF : DLXHM

699 € excl. VAT

Features

Battery 3,6 V - 17 Ah - Battery life 1 to 7 years*	Probe diameter 20 mm	Minimum probe insertion min. 35 mm Total length 220 mm
Metal connector, waterproof and robust	Bluetooth & LPWAN Radio connection	Protection IP65
Accuracy +/-2 % (20-80%) à 25 °C and +/-3 %	Measurement interval 10 min to 24 h	Wall mounting
Internal memory 250,000 measurements	Operating temperature -30 °C to +75 °C	Measurable moisture 0-100 %

*depending on measurement frequency, sensor exposure, and data transmission mode (Bluetooth, LPWAN, etc.)

Included in the pack

- 1 DELTA X sensor
- 1 battery 3.6 V
- 1 stainless steel U-bracket
- 4 screws M6 × 8, INOX A2
- 2 universal anchors 10 × 60, NYLON
- 2 round-head wood screws 6 × 70, INOX A2
- 2 flat washers M6, INOX A2
- 1 Hm probe
- 2 wood screws 5 × 60, INOX A2
- 2 universal anchors 8 × 52, NYLON
- 2 flat washers M5, INOX A2

Mounting advice

- T20 screwdriver
- T30 screwdriver for mounting screws
- Drill bit adapted to the material Ø 25 mm
- T25 screwdriver

DELTA X-Hm

sold separately



Logger X

REF : DLLX

449 € excl. VAT



Material moisture probe

REF : SHM

275 € excl. VAT



Use case

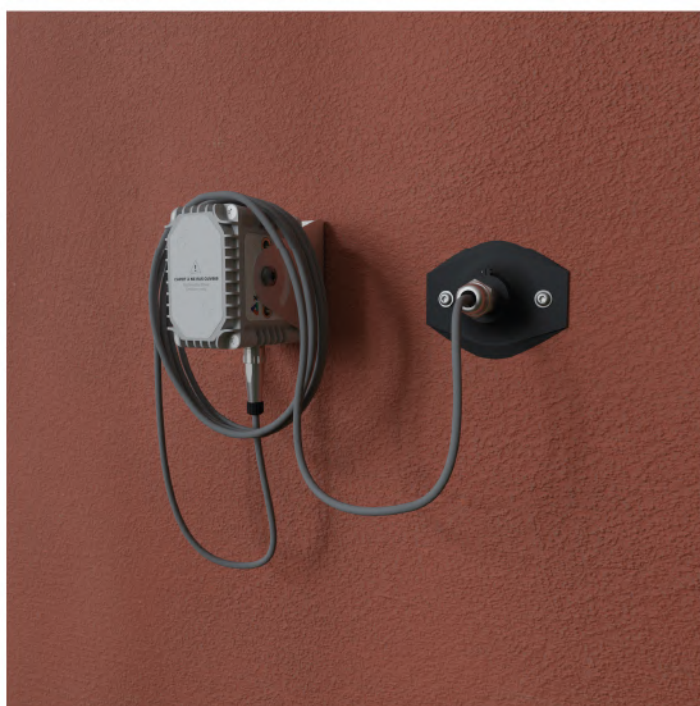



THE RAIN GAUGE SENSOR



DELTA X-Ra

The DELTA X-Ra sensor is a tipping bucket rain gauge designed to measure precipitation reliably, accurately, and without secondary calculations.

REF : DLXRa

699 € excl. VAT

Features

battery 3,6 V - 17 Ah - battery life 1 to 7 years*	protection enclosure IP66	Operating temperature -25 °C à +70 °C
Resolution 0,2 mm	Bluetooth & LPWAN radio connectivity	Power consumption < à 100µW
Accuracy ≤ ±3%	Measurement interval from 10 min to 24 h	Rain collection area 200 cm ²
Internal memory 250,000 measurements	Pulse outputs	Wide intensity range 0 to 4 mm/min

*Depending on frequency, sensor exposure, and data transmission mode (Bluetooth, LPWAN, etc.)

DELTA X-Ra

sold separately



Logger X

REF : DLLX

449 € excl. VAT



Rain gauge probe

REF : SEM2E

275 € excl. VAT



Use case





DATA LOGGER

Logger

DELTA X

The DELTA X logger is the ideal solution to connect all your FEELBAT sensors. Easy to install (plug & play) and requiring no heavy works, it transmits data in real time and remotely.

Measurements can be viewed on an intuitive web platform or via the FEELBAT mobile application, providing clear visualization of trend curves and configurable alerts.



Compact & Resistant



Precise



Plug & Play



Autonomous



Connected

Our range of compatible sensors



DELTA X-L100

Large-amplitude crack monitoring



DELTA X-L100S

Submersible crack monitoring



DELTA X-P

Groundwater level monitoring



DELTA X-Hs

Soil moisture monitoring



DELTA X-Ha

Ambient humidity monitoring



DELTA X-Hm

Material moisture monitoring



DELTA X-Ra

Rain gauge sensor

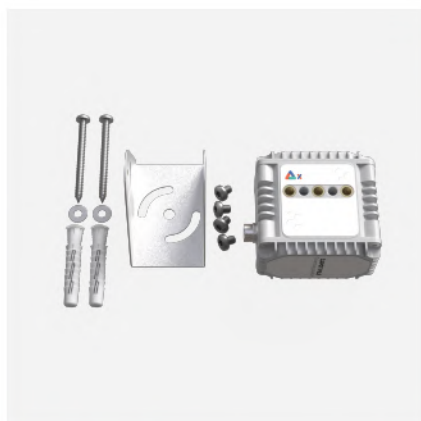

DELTA X

The DELTA X is a logger equipped with a 4–20 mA port, allowing the connection of sensors from the FEELBAT range.

Thanks to its fast installation, it provides accurate, centralized, and remote monitoring.

REF : DLLX

449 € excl. VAT

Features

Battery 3,6 V - 17 Ah - Battery life 1 to 7 years*	Weight 350 g	Dimensions 8 x 8 cm / Thickness 5 cm
Compatible 4 - 20 mA	Connectivity Bluetooth & LPWAN radio	Protection IP66
Integrated connector	Measurement interval 10 minutes to 24 h	Versatile measurement of various physical parameters
Internal memory 250 000 measurements	Operating temperature -25 °C to +70 °C	Technical details see datasheets of compatible sensors

*Depending on measurement frequency, sensor exposure, and data transmission mode (Bluetooth, LPWAN, etc.).

Included in the pack

- 1 DELTA X logger
- 1 D-type 3.6 V battery
- 1 stainless steel U-bracket
- 4 M6 × 8 screws, stainless steel A2
- 2 universal wall plugs, 10 × 60, nylon
- 2 round-head wood screws 6 × 70, stainless steel A2
- 2 flat washers M6, stainless steel A2

Mounting advice

- T20 screwdriver
- Ø10 mm drilling for nylon wall plug
- T30 screwdriver for fastening screws
- T25 screwdriver

Compatible probes

Sold separately



Potentiometric probe

REF: SXL100

325 € excl. VAT



Soil moisture probe

REF: SXH

275 € excl. VAT



10 m

Piezometric probe

10 m

REF: SXP10

449 € excl. VAT



20 m

Piezometric probe

20 m

REF: SXP20

549 € excl. VAT



Ambient humidity probe

REF: SHA

275 € excl. VAT

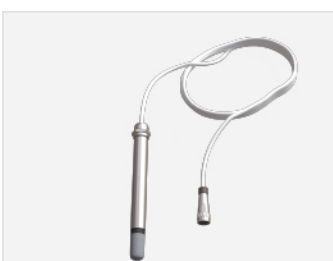

Material moisture probe

REF: SHM

275 € excl. VAT



Rain gauge probe

REF: SEM2E

275 € excl. VAT

Data retrieval

Via Bluetooth or long-range connection



BLUETOOTH

Connection to your sensors when you are nearby (up to 30 meters in open field) to retrieve your data.



RÉSEAU SIGFOX*

Connection to your sensors from anywhere to retrieve your data using the Linkfeel token.

Data retrieval

Nearby - bluetooth



DELTA Feel electronic sensors can operate without requiring a Linkfeel token.

The sensors record data autonomously, and you can retrieve it via Bluetooth connection from your smartphone, within a maximum distance of 30 meters in line of sight.

Once the data has been retrieved, you can upload it to the FEELBAT cloud using your 3G/4G connection. This allows you to access and view the data from another smartphone or computer.

Data retrieval

Remote - Linkfeel token



DELTA Feel electronic sensors can be activated with a Linkfeel token, enabling remote data transmission for one year or more.

The sensor stores the data internally and sends it via the Sigfox or LTE-M network to the FEELBAT cloud, allowing you to consult it on your smartphone or computer and receive alerts if required.

However, in some remote locations (non-covered areas) or underground, the Sigfox network may not be available. This is why we provide our customers with alternative solutions.



Test Button

The test button is the ideal tool for situations where the exact site address has yet to be determined or when selecting the precise location for your sensors. Once activated, it allows you to test Sigfox network coverage in the area, ensuring the proper operation of your monitoring system.

REF : DET2

90 € excl. VAT

Includes 1 year of connection



Repeater

The repeater extends the range of sensors in areas with low Sigfox coverage.

It can relay data from up to 15 sensors (140 messages/day) and operates on battery power with a lifespan of 1 to 7 years, depending on usage. A 1-year subscription is included, renewable with a Linkfeel token.

REF : RPT1

139 € excl. VAT

Includes 1 year of connection



SIGFOX Microstation

The Sigfox microstation extends Sigfox coverage in indoor environments or poorly covered areas.

It operates on 220 V power with Ethernet or optional 3G/4G connectivity. An IP65 enclosure is recommended for outdoor use. 3G/4G USB keys are optional, SIM card not included.

REF : BOX1

599 € excl. VAT



FEELBOX

The FEELBOX, our new 4G gateway, provides optimal network coverage for your FEELBAT sensors when the Sigfox network is insufficient.

Where your phone has 4G coverage, your FEELBAT sensors will too. Operates with Linkfeel tokens (not included).

REF : GFBX

350 € excl. VAT

The mobile App

Download the app

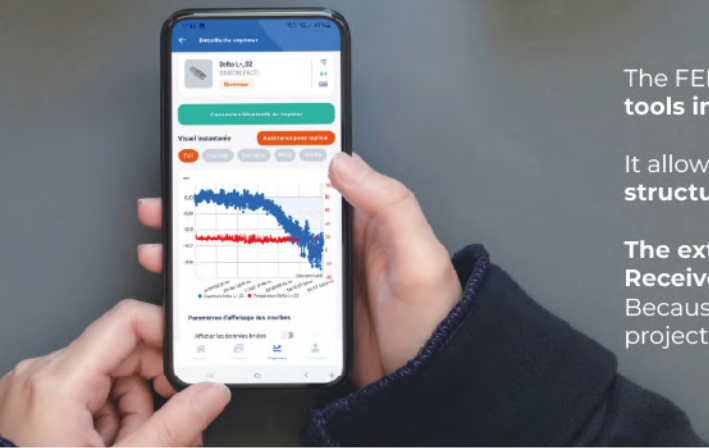

The FEELBAT app is the only mobile application that brings together all tools in one simple and easy-to-use solution.

It allows you to install your sensors, configure them, and monitor your structures in real time, whether you are on-site or working remotely.

The extra benefit?
Receive alerts when thresholds are exceeded.

Because prevention is essential, you and all collaborators involved in the project can receive alerts whenever a predefined threshold is crossed.

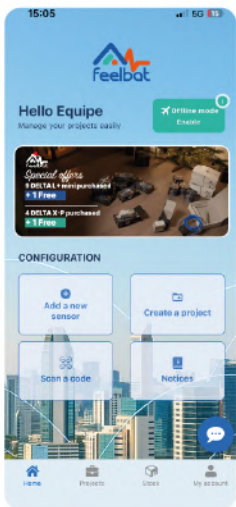

Create your project
Start by creating a project to which you can associate different sensors and monitor them easily.

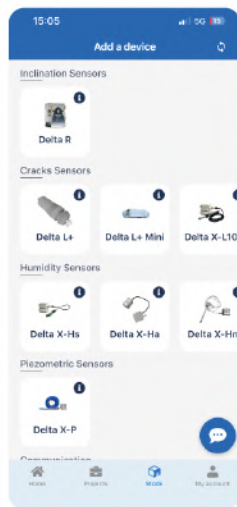

Add your sensor
Add the various sensors present on your site, according to their type.



Connect your sensor
Connect your sensors via Bluetooth.

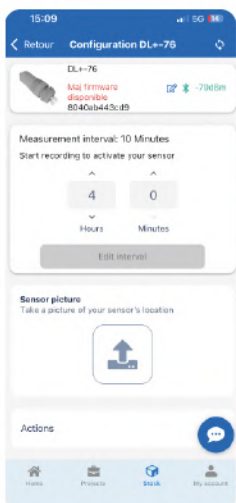

Configure measurement intervals
Edit the measurement intervals according to your monitoring needs.



Configure thresholds
Set alert thresholds to receive notifications in case of exceedance.

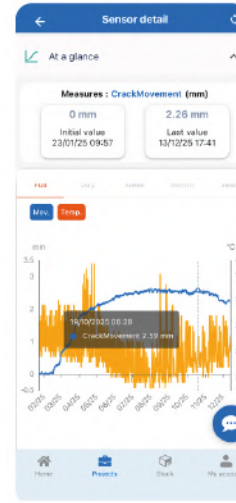

View your data
Monitor all your data in real time, with predefined measurement intervals.

The web application

Go further!

All features available in the mobile app will also be accessible on the web to make analysis and graph comparison easier.

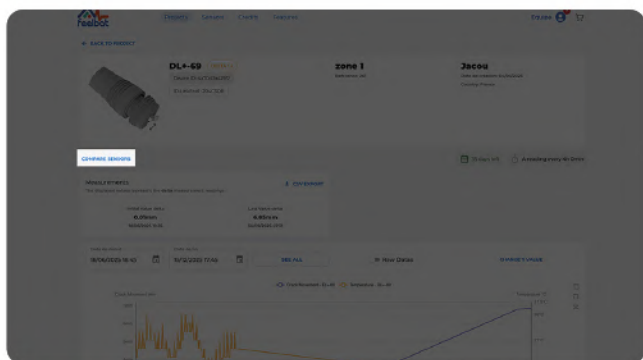
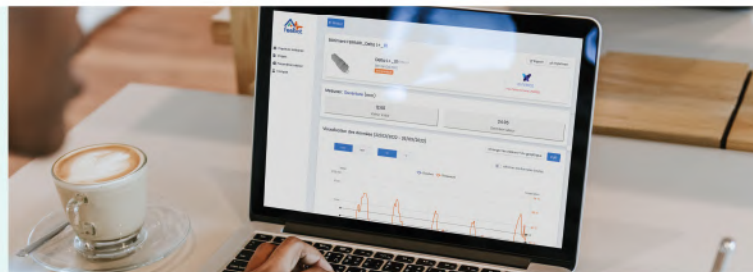

Compare sensors

On your sensor page, easily compare similar models or sensors measuring the same parameter (e.g., XCI vs DELTA L+).

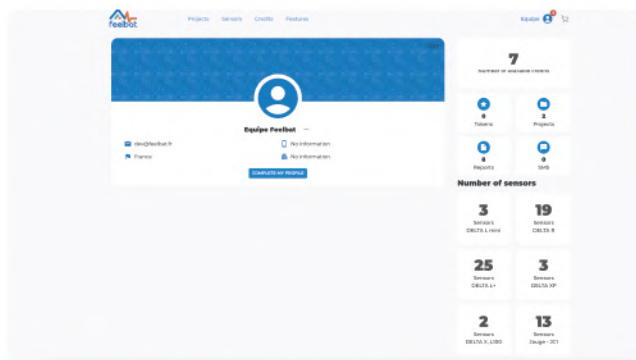

Access your information

Quickly access your sensors, subscriptions, LinkFeel tokens, and their expiration dates.

Automate your reports

Generate your PDF report in just a few clicks, including all your essential data.

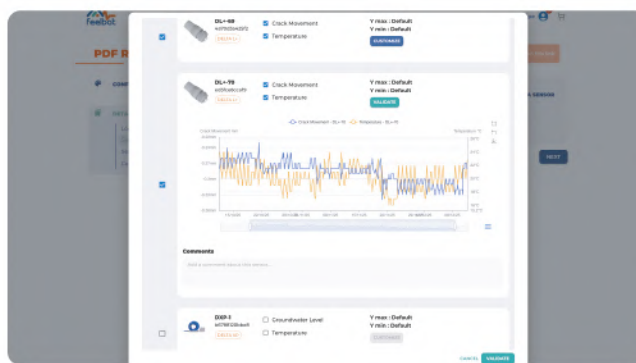

Customize your report

Colors, logos, curves... Customize your PDF report to fit your needs.

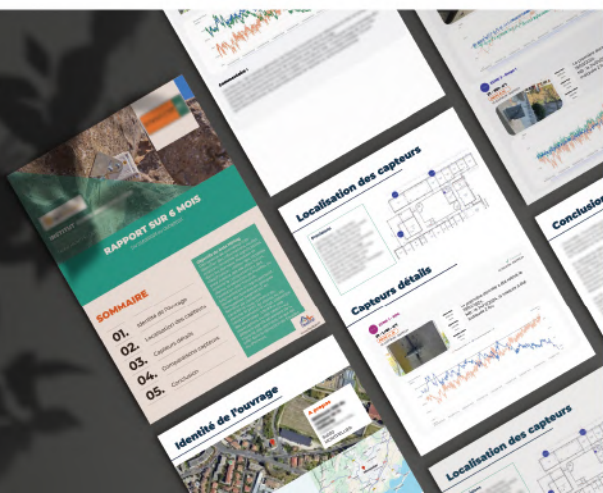

PDF REPORT

Generate your reports automatically and customize them in just a few clicks!

[See a sample report](#)

Support and Training

Personalized assistance



Phone support in less than

24h



ADVICE

FEELBAT is made up of structural engineering specialists dedicated to advising and technically supporting you according to your specific needs. They assist you in validating the choice and positioning of sensors.

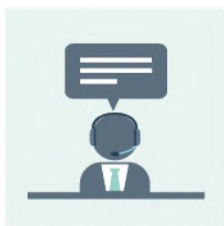

SUPPORT

Technical support is provided upstream of the project to create the right conditions for success. In addition, phone support on the day of installation can be scheduled to answer all your questions.

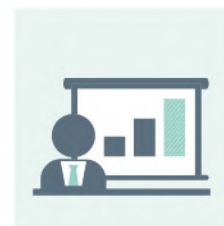

TRAINING

Our solution is designed to be simple yet comprehensive. A one-hour remote training session is available to help you get started with the application and fully use all features according to your needs.

Prerequisite: you must create an account and download the FEELBAT application before the training session.

Duration, schedule and delivery format

- Minimum participants: 1 person
- Maximum participants: 5 people
- Duration: 1 hour
- Format: videoconference

ASSISTANCE SESSION

Do you need help preparing your site or installing your sensors?

One of our experts will assist you during a 30 min video call to guide you and answer all your questions.

REF : FORMAT

99 € excl. VAT

Buy credits to unlock web and mobile features

Excl. VAT price	Bonus	Number of credits
10 €		1 credit
250 €	1 FREE	26 credits
1000 €	5 FREE	105 credits
3 000 €	30 FREE	330 credits

Features available with your credits

	Included	Optional purchase	Cost (credit)
Management			
Number of sensors	Unlimited		
Number of basic projects*	2 included at account creation	+1	2 credits
Upgrade basic project to Expert (Level 1)*	0	1	+3 credits
Connectivity			
LINKFEEL token <small>(1 year remote connection – Sigfox or FEELBOX 4G)</small>	0	1 token	10 credits/year
PDF Reports			
Number of report generations	5	10 reports	5 credits

Add 2 credits to create a basic project, then +3 additional credits to upgrade it to Expert mode and unlock advanced features.

*Project offer details	Basic Project 2 credits per project	Expert Project +3 credits per project
Project sharing <small>Reading mode</small>	✓	✓
Advanced project sharing <small>Data presentation, full project report</small>	✗	✓
Measurement interval <small>per project</small>	= / > 4h	Up to 10 min
Email alerts	✗	Unlimited
SMS alerts	✗	100 SMS 5 credits
Level 1 monitoring files <small>Temperature curves ax+b (possibility of weighting the curves to refine the analysis)</small>	✗	✓
Deformation module	✗	✓

Old Account Process

1. You start by purchasing credits.

Example: you pay €500 and receive 50 credits + 2 bonus credits = 52 credits total.

2. You use your credits as you wish.

Each feature is activated using a specific number of credits.

- **Want to connect for 1 year?**

You spend 10 credits (LINKFEEL token).

You have 42 credits remaining.

- **Want to add 4 additional projects beyond the 2 free ones?**

Each project costs 2 credits.

4 projects = $4 \times 2 = 8$ credits.

You have 34 credits remaining.

- **Want 2 of these projects in Expert mode (measurements every 10 minutes)?**

Expert mode costs 3 credits per project, so $2 \times 3 = 6$ credits.

You have 28 credits remaining.

💡 In Expert mode, you get all features (except SMS alerts).

- **Want to receive SMS alerts?**

A pack of 100 SMS costs 5 credits (valid for all Expert mode projects).

$28 - 5 = 23$ credits remaining.

✅ You therefore still have 23 credits, which you can use later.

Good news: credits never expire.

Account Creation Process

1. When you open your account, you already have features available

You get:

2 basic projects, 5 PDF report generations, Project sharing in read-only mode, A measurement interval ≥ 4 hours

2. Then, the same process applies,

You purchase credits and use them as you wish.

- **Want to upgrade your 2 basic projects to Expert mode?**

Go to your projects, click on the orange frame, then select

“Upgrade my project to Expert mode” for only 3 credits.

Sensor Maintenance



DELTA L+ Maintenance

- Battery replacement
- Inspection of components and measurements, with replacement of faulty parts
- (in the event of damage caused by improper use, an additional quotation will apply)
- Replacement of sealing gaskets
- Firmware update

REF : DLL+MAINT

89€ excl. VAT



DELTA R Maintenance

- Battery replacement
- Inspection of components and measurements, with replacement of faulty parts
- (in the event of damage caused by improper use, an additional quotation will apply)
- Replacement of sealing gaskets
- Firmware update

REF : DLLRMAINT

99€ excl. VAT



If you have a crack You FEELBAT

Contact us



contact@feelbat.fr



04 123 800 90



www.feelbat.fr



info@feelbat.fr
04 123 800 90



4 rue Louis Breguet
JACOU 34830 FRANCE
head office 20 rue Maxime Riviere
97490 SAINT-DENIS



www.feelbat.fr
in f o